

1

2

3

4

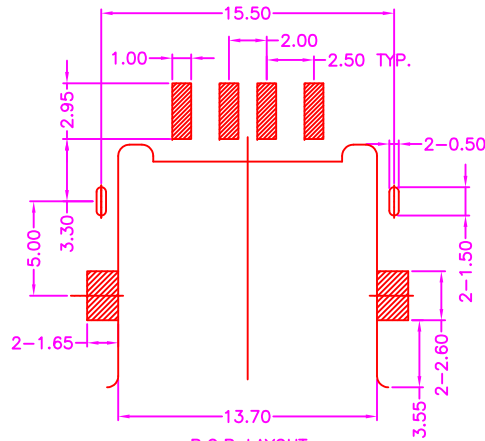
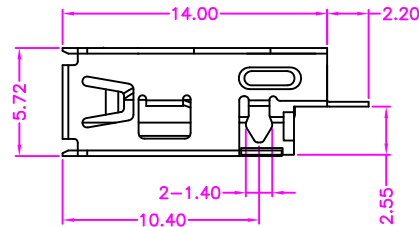
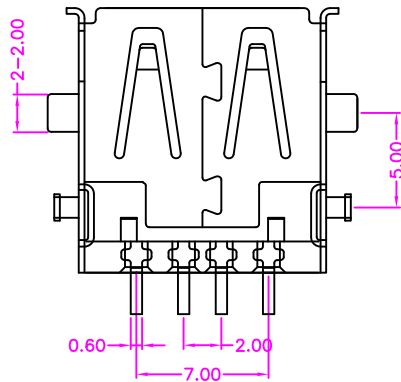
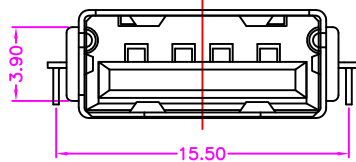
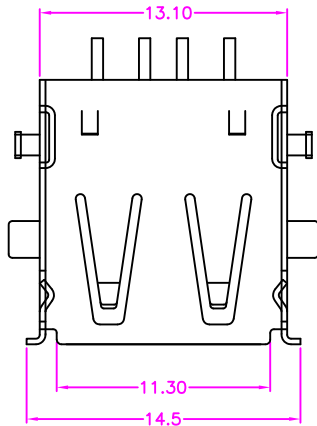

P.C.B. LAYOUT
TOP VIEW ±0.05

MATERIALS

HOUSING: LCP (UL 94V-0)
 SHELL: STAINLESS STEEL, GOLD PLATING
 TERMINAL: COPPER ALLOY, GOLD PLATED ON CONTACT AREA
 TIN PLATING ON SOLDER TAIL

SPECIFICATION

CURRENT RATING: 1 AMP MAX
 DIELECTRIC WITHSTANDING: 500V AC FOR ONE MINUTE
 CONTACT RESISTANCE: 30m OHMS MAX
 INSULATION RESISTANCE: 1000M OHMS MIN AT DC 500V
 OPERATION TEMPERATURE: -25°C~+85°C

PART NUMBER

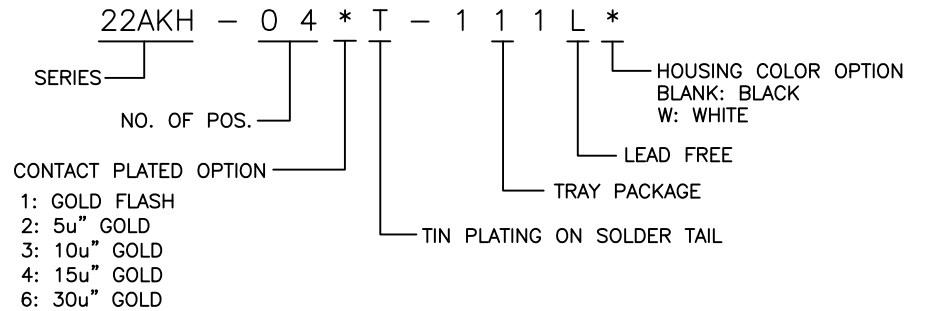

淮洋有限公司 HUAI YANG CO., LTD.		SERIES: USB CONNECTOR SERIES	
LINEAR: .X±0.30 .XX±0.20 .XXX±0.10		TITLE: USB A TYPE, PCB MOUNT, SMT, BOARD CUT, METAL SHIELD, FEMALE, REVERSE TYPE	
ANGLES: ±3°		APPROVALS DRAWN: <i>Mans</i> CHECKED: <i>Lion</i> APPROVED: <i>James</i>	
		SIZE: A4	VERSION: A
10026		DWG NO. 22AK-002	
		SCALE: NONE	UNIT: mm
		SHEET: 1 OF 1	

A	RELEASE	2009.5.4
REV.	DESCRIPTION	DATE

1

2

3

4

A

A

B

B

C

C

D

D