



淮洋有限公司 HUI YANG CO.,LTD.
 TEL : 886-2-8261-8986 FAX : 886-2-8261-1885
 www.hy1688.com.tw 236新北市土城區中央路二段191號10樓之5



Feature -

- water proof IP67 sealed
- bi-color LED illuminated available
- SMT, right angle, and vertical PCB terminal

Application -

- consumer products
- computer products
- instrumentation
- communication equipments

► **SPECIFICATIONS**

SWITCH SPECIFICATIONS	
POLE - POSITION	Momentary action , SPST
CONTACT RATING	12 V DC , 50 mA
CONTACT RESISTANCE	100 mΩ MAX. 5 V DC ; 1 A , by Method of Voltage DROP
INSULATION RESISTANCE	1000 MΩ MIN. 100 V DC for 1 minute
DIELECTRIC STRENGTH	Breakdown is not Allowable ; 250 V AC for 1 Minute
OPERATING FORCE	200 ± 80 gf ; 450 ± 150 gf
OPERATING LIFE	500,000 cycles
OPERATING TEMPERATURE RANGE	-20°C ~ 70°C
TOTAL TRAVEL	0.45 ± 0.15 mm
SEALING	IP67

LED SPECIFICATIONS		Value / LED Color			
	Unit	Blue	Green	Red	Yellow
		 ATTENTION LEDs are Electrostatic Sensitive devices			
FORWARD CURRENT	If	20	20	20	20
REVERSE VOLTAGE	Vr	5.0	5.0	5.0	5.0
REVERSE CURRENT	Ir	10	10	10	10
FORWARD VOLTAGE@20mA	Vf	3.5-3.8	2.0-2.5	2.0-2.5	2.0-2.5
LUMINOUS INTENSITY@20mA	Iv	45	20	80	80

■ Physical and electrical information of LED will be provided upon customer's request on switches .

► **HOW TO ORDER**

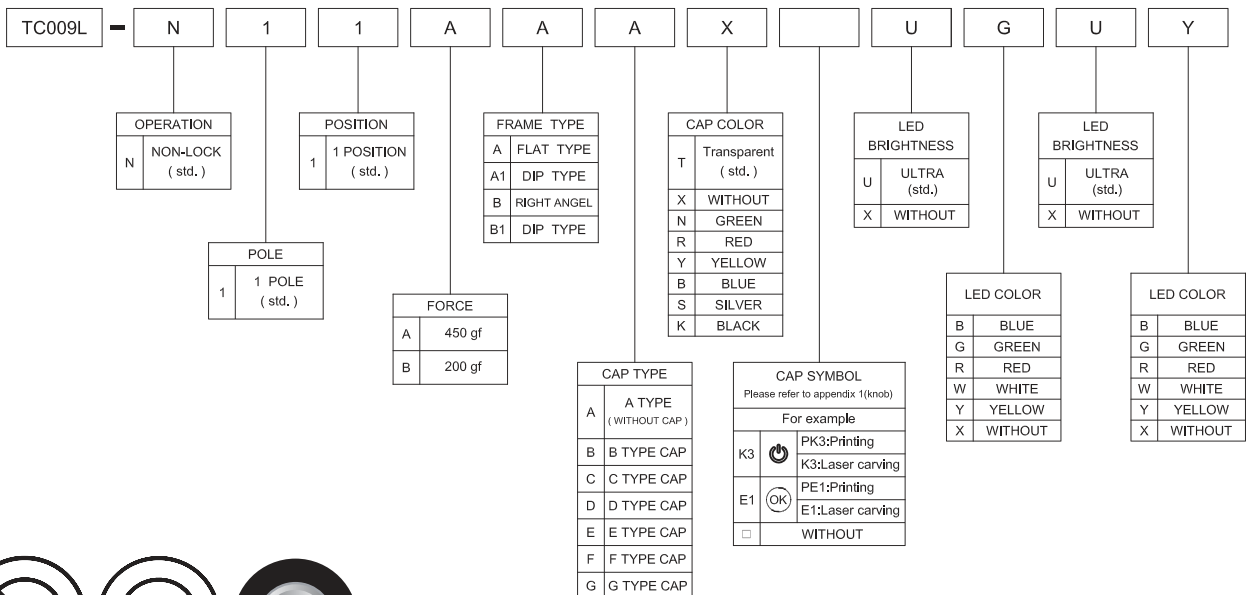

DIMENSION & FRAME TYPE

TC009L-N11AAAX □ □ □ □

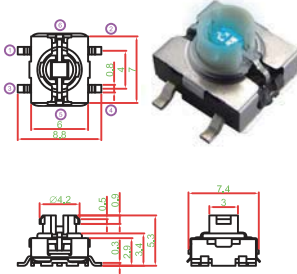

TC009L-N11AA1AX □ □ □ □

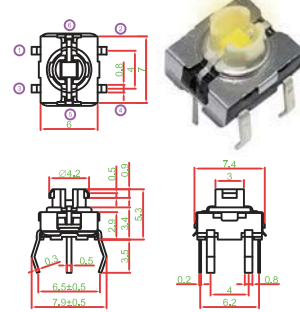

TC009L-N11ABAX □ □ □ □

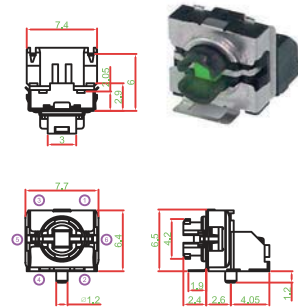

TC009L-N11AB1AX □ □ □ □

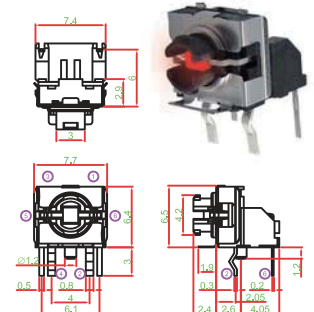

KNOB TYPE OPTION

B TYPE

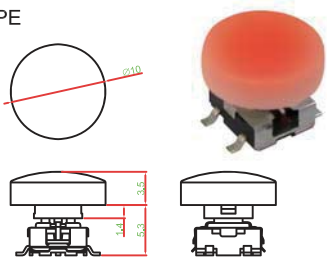

C TYPE

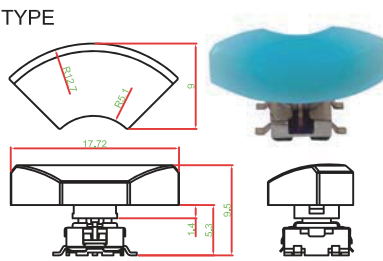

D TYPE

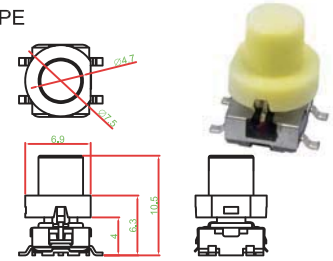

E TYPE

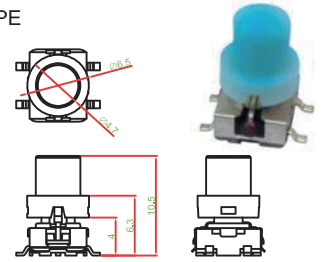

F TYPE

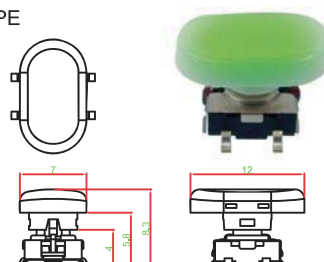

G TYPE

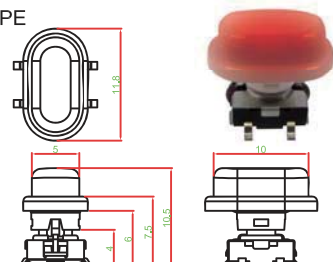

SCHEMATIC

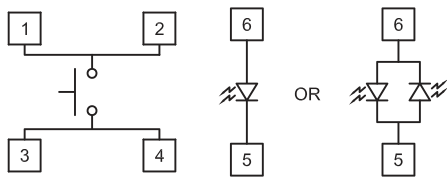

P.C.B LAYOUT

FRAME : A

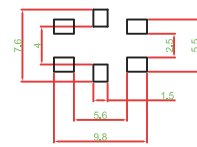

FRAME : B

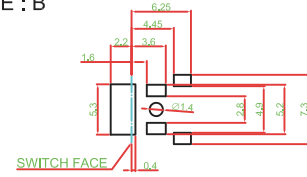

FRAME : A1

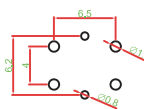

FRAME : B1

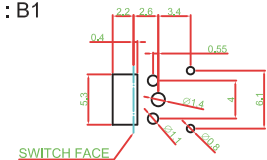

REFLOW SOLDERING

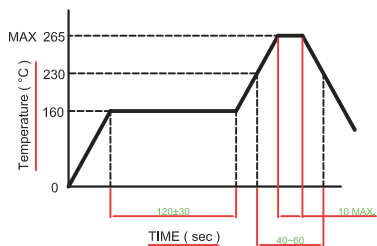

MATERIAL

- COVER : STAINLESS STEEL
- ACTUATOR : LCP+GF
- BASE : LCP+GF
- TERMINAL : BRASS SILVER PLATING
- SPRING PLATE : PHOSPHOR BRONZE SILVER PLATING

