

Feature :

- Compact size
- Reflow soldering available

Application :

- Consumer products
- Computer products
- Instrumentation
- Communication equipments
- Hand-held devices

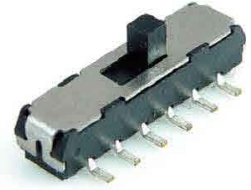

| SWITCH SPECIFICATIONS | |
|-----------------------------|---|
| POLE - POSITION | 4P2T |
| CONTACT RATING | 6 V DC , 0.3 A |
| CONTACT RESISTANCE | 70 mΩ MAX. 5 V DC ; 1 A , by Method of Voltage DROP |
| INSULATION RESISTANCE | 100 MΩ MIN. 500 V DC for 1 minute |
| DIELECTRIC STRENGTH | Breakdown is not Allowable ; 500 V AC for 1 Minute |
| OPERATING FORCE | 200 ± 150 gf |
| OPERATING LIFE | 10,000 cycles |
| OPERATING TEMPERATURE RANGE | 40°C ~ 85°C |
| TOTAL TRAVEL | 2.0 ± 0.3 mm |

HOW TO ORDER

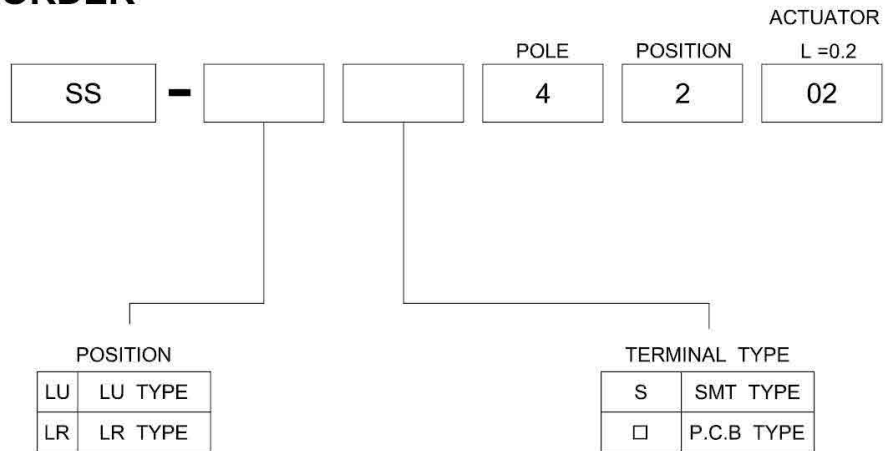

DIMENSION

• SS-LUS4202

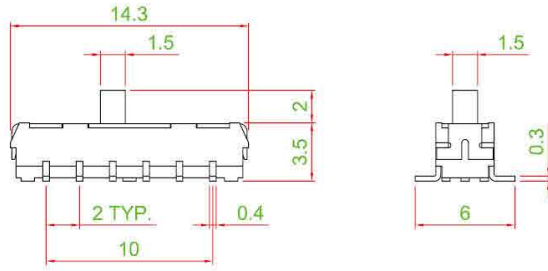
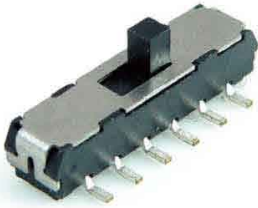

P.C.B. LAYOUT

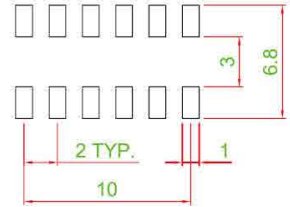

• SS-LRS4202

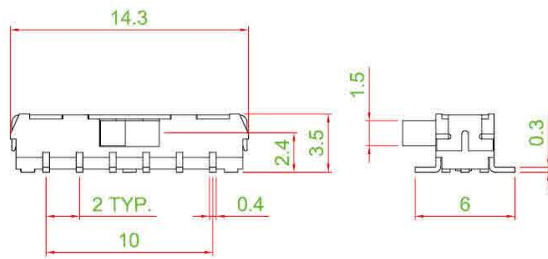

P.C.B. LAYOUT

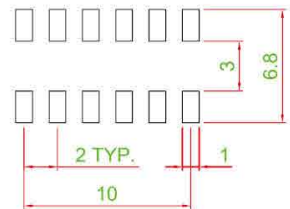

• SS-LU4202

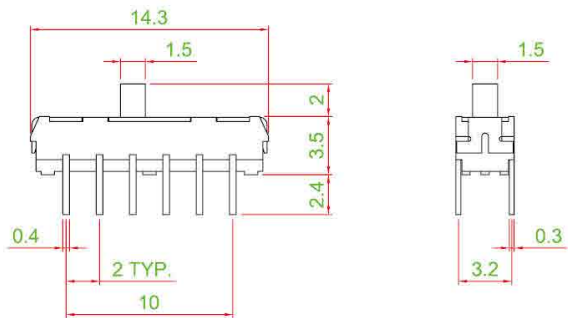

P.C.B. LAYOUT

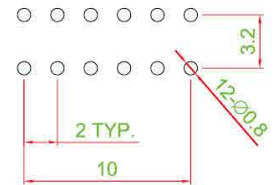

• SS-LR4202

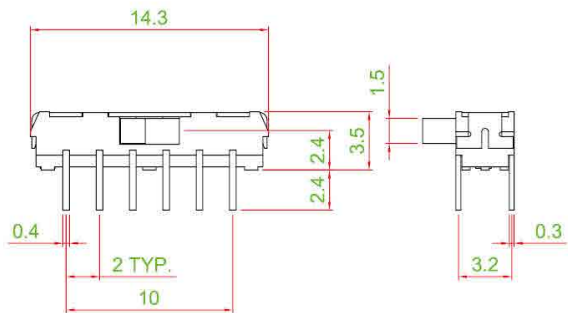
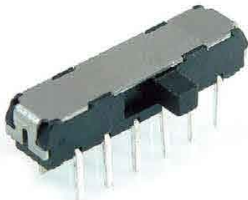

P.C.B. LAYOUT

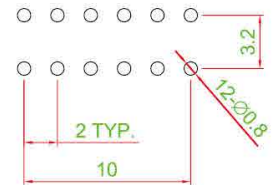

CIRCUIT

