

淮洋有限公司 HUI YANG CO., LTD.

SENSOR SWITCH

Item No.	RBS3201 系列	Description	TILT SWITCH	Version	14
Page	1 of 15		Date	Oct. 05, 2015	

● 功能

1. 單向傾斜偵測
2. 上下翻轉偵測
3. 垂直旋轉偵測



● 應用

- 1 液晶螢幕翻轉
- 2 電熨斗位置偵測
- 3 無線滑鼠
- 4 機車防盜
- 5 需要上下翻轉自動斷電之裝置或系統

● 特性

- 1 外殼採用高絕緣性塑膠材料，可避免外殼導電或生鏽。
- 2 採用光電晶體感測訊號，訊號穩定、可靠。
- 3 所有塑膠材料均使用高耐溫之工程塑膠。
- 4 開關訊號單純，線路設計容易。
- 5 符合 RoHS 標準，完全替代水銀開關。
- 6 比 IC 設計經濟的解決方案。
- 7 台灣製造，出廠全檢。

● 專利

1. 台灣專利第 I 321332 號
2. 美國專利第 US 7,485,818 B2 號
3. 中國專利第 ZL 200610078607.7 號



SENSOR SWITCH

Item No.	RBS3201 系列	Description	TILT SWITCH	Version	14
Page	2 of 15		Date	Oct. 05, 2015	

● 尺寸 / 運用 / 電路板佈線圖 (單位: mm,公差: ±0.25mm)

(圖 1)

<p>RBS 32 01 00</p>	<p>Operation Angle $\theta=8^{\circ}+10^{\circ}/-5^{\circ}$</p>
<p>P.C.B. Layout(DIP)/Top View</p>	<p>Application Circuit</p>



SENSOR SWITCH

Item No.	RBS3201 系列	Description	TILT SWITCH	Version	14
Page	3 of 15		Date	Oct. 05, 2015	

(圖 2)

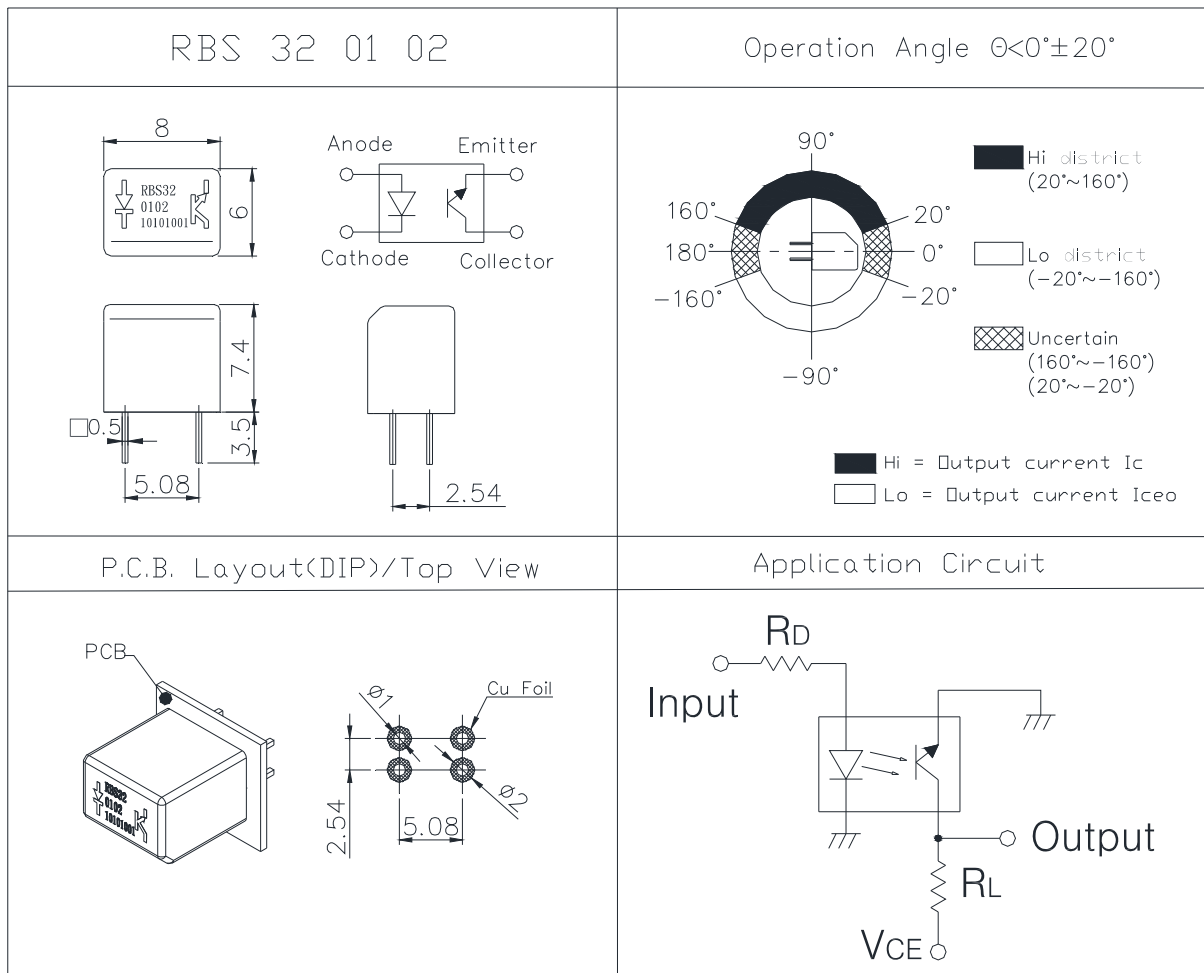

SENSOR SWITCH

Item No.	RBS3201 系列	Description	TILT SWITCH	Version	14
Page	4 of 15		Date	Oct. 05, 2015	

(圖 3)

<p>RBS 32 01 03</p>	<p>Operation Angle $\theta=30^{\circ}\pm 10^{\circ}$</p>
<p>P.C.B. Layout(DIP)/Top View</p>	<p>Application Circuit</p>



SENSOR SWITCH

Item No.	RBS3201 系列	Description	TILT SWITCH	Version	14
Page	5 of 15		Date	Oct. 05, 2015	

(圖 4)

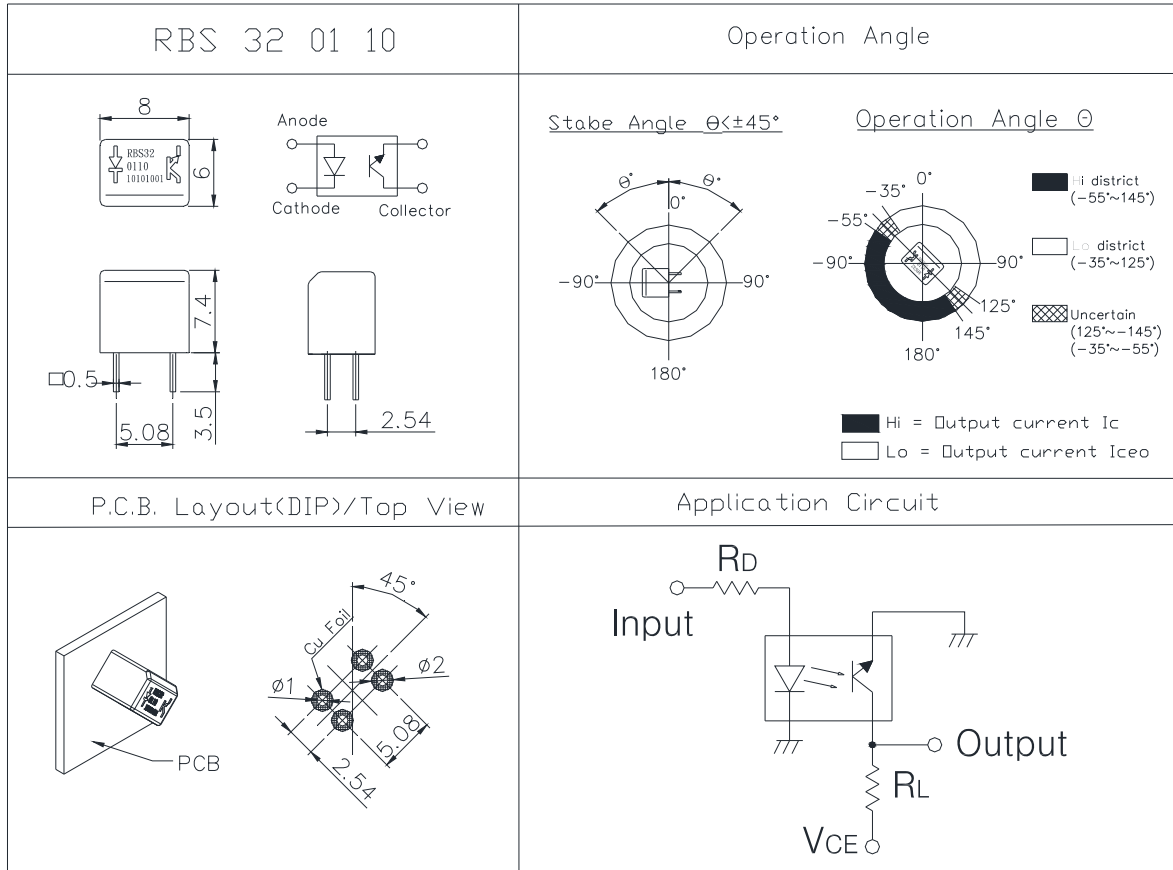

SENSOR SWITCH

Item No.	RBS3201 系列	Description	TILT SWITCH	Version	14
Page	6 of 15		Date	Oct. 05, 2015	

● 建議電流、電壓條件

輸入電流 (mA)	操作電壓 (V)	條件
10	3.3	$V_{CE}=3.3V$ $R_D = 200 \text{ ohm}$ $R_L = 15K \text{ ohm}$
10	5	$V_{CE}=5V$ $R_D = 390 \text{ ohm}$ $R_L = 22K \text{ ohm}$

* 相關電路設計請參考上述 Application Circuit。

● Absolute Maximum Rating (Ta=25°C)

Item		Symbol	Rating	Unit
Input	Power Dissipation	P_d	75	mW
	Reverse Voltage	V_R	5	V
	Forward Current	I_F	50	mA
	Peak Forward Current (*1)	I_{FP}	1	A
Output	Collector Power Dissipation	P_C	100	mW
	Collector Current	I_C	20	mA
	C-E Voltage	V_{CEO}	30	V
	E-C Voltage	V_{ECO}	5	V
Operating Temperature		T_{opr}	-25~+85	°C
Storage Temperature		T_{stg}	-40~+85	°C
Soldering Temperature (*2)		T_{sol}	260	°C

(*1) $t_w=100 \mu\text{Sec.}$ 、 $T=10 \text{ mSec.}$

(*2) $t=5 \text{ Sec}$



SENSOR SWITCH

Item No.	RBS3201 系列	Description	TILT SWITCH	Version	14
Page	7 of 15		Date	Oct. 05, 2015	

● 光電、電性特性 (Ta=25°C)

Parameter	Symbol	Condition	Min.	Typ.	Max.	Unit
Forward Voltage	V_F	$I_F=20mA$	-	1.2	1.5	V
Reverse Current	I_R	$V_R=5V$	-	-	10	μA
Peak Wavelength	λ_p	$I_F=10mA$		940		nm
Dark Current	I_{ceo}	$V_{CE}=10V$	-	-	100	μA
C-E Saturation Voltage	$V_{CE} (sat)$	$I_C=0.25mA$ $I_F=20mA$	-	-	0.4	V
Light Current	I_c	$V_{CE}=5V$ $I_F=20mA$	0.5	5	-	mA
Rise Time	T_r	$I_C=0.8mA$ $V_{CC}=30V$ $R_L=1K\Omega$	-	5	-	μsec
Fall Time	T_f		-	5	-	μsec



SENSOR SWITCH

Item No.	RBS3201 系列	Description	TILT SWITCH	Version	14
Page	8 of 15		Date	Oct. 05, 2015	

● 光電、電性特性曲線 (Ta=25°C)

Fig.1 Power Dissipation vs. Ambient Temperature

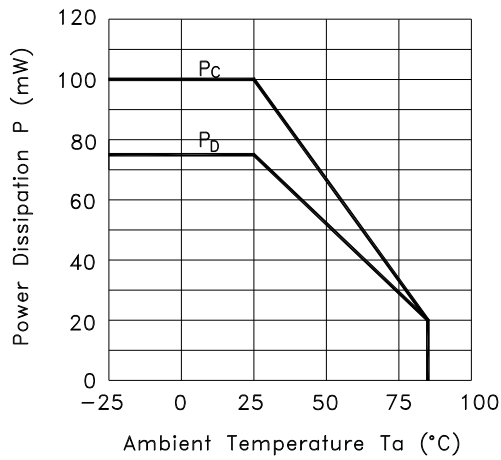

Fig.2 Forward Current vs. Forward Voltage

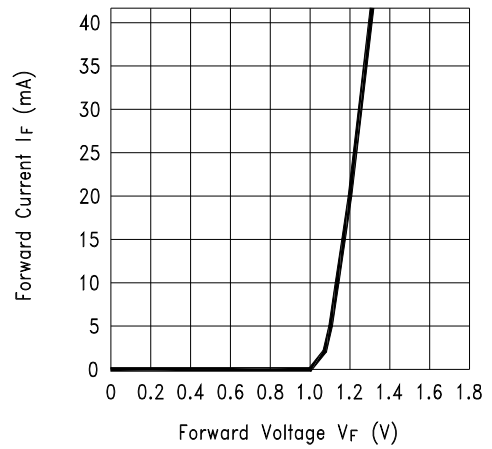

Fig.3 Collector Current vs. Collector-emitter Voltage

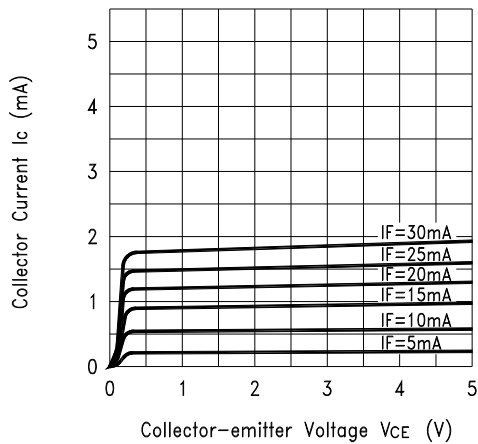
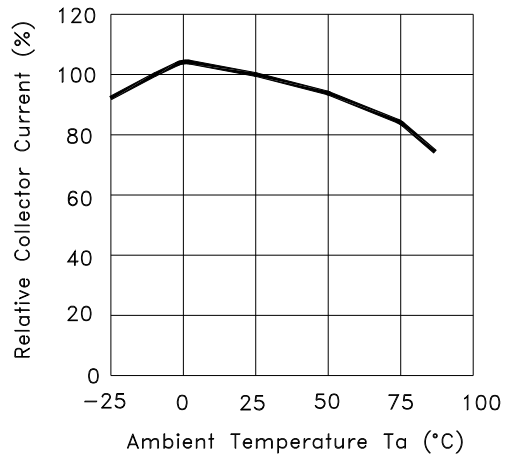

Fig.4 Collector Current vs. Ambient Temperature



SENSOR SWITCH

Item No.	RBS3201 系列	Description	TILT SWITCH	Version	14
Page	9 of 15		Date	Oct. 05, 2015	

Fig.5 Collector-emitter Saturation Voltage vs. Ambient Temperature

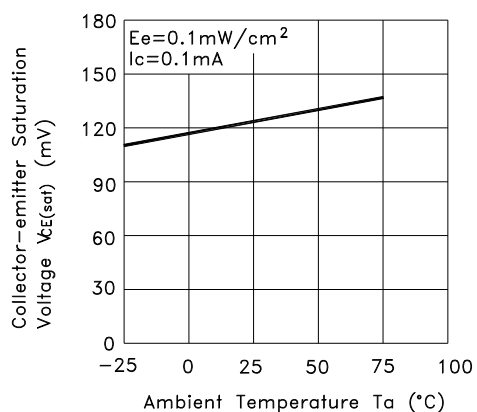

Fig.6 Response Time vs. Load Resistance

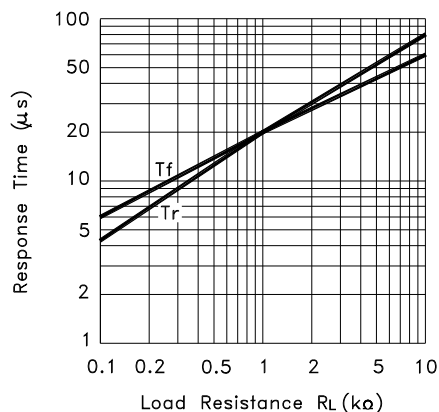
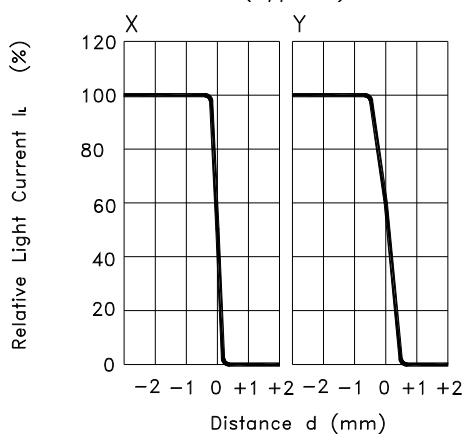
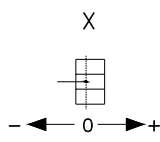

Fig.7 Sensing Position Characteristics (Typical)



(Center of Optical axis)



Test Circuit for Response Time

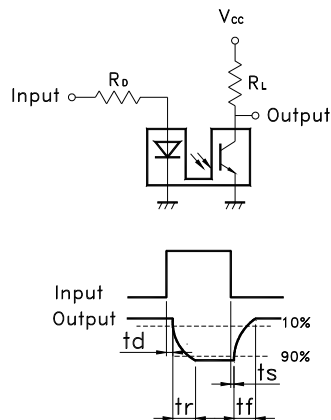

SENSOR SWITCH

Item No.	RBS3201 系列	Description	TILT SWITCH	Version	14
Page	10 of 15		Date	Oct. 05, 2015	

● 電性/電氣特性

1	接點容量	--
2	接觸電阻	--
3	角度差	參考圖 1~圖 4
4	絕緣電阻	--
5	介電強度	--
6	電容量	--

● 可靠度測試項目

以下的表格呈現的是 RBS3201 系列的操作壽命、機械、與環境測試。

測試項目	依據規範	測試內容
迴焊爐	--	--
操作溫度	MIL-STD-202G, TEST METHOD 107G, TEST A	-25°C~85°C
儲存溫度	MIL-STD-202G, TEST METHOD 107G, TEST A	-40°C~85°C
濕度	MIL-STD-202G, TEST METHOD 103B	40°C/95%RH
機械壽命	--	2Hz, horizontal 1,000,000 times
電氣壽命	MIL-STD-883E:1016	I _F =20 mA, V _{CE} =5 V TIME: 30,000 hrs



SENSOR SWITCH

Item No.	RBS3201 系列	Description	TILT SWITCH	Version	14
Page	11 of 15		Date	Oct. 05, 2015	

● 焊錫條件

以下焊錫條件僅供參考，建議使用者依照焊劑製造商推薦的焊接檔案資料來進行。

操作方式 \ 條件	焊接溫度	焊接時間	烙鐵瓦數	適用製程
迴流焊接	詳如以下迴焊資料及(圖 5)		-	SMT
波峰焊接	260±5°C	< 5 seconds max.	-	DIP
烙鐵焊接	260±5°C	< 5 seconds max.	20W 或 溫控烙鐵	DIP、SMT



SENSOR SWITCH

Item No.	RBS3201 系列	Description	TILT SWITCH	Version	14
Page	12 of 15		Date	Oct. 05, 2015	

< 迴焊資料分類表 >

主要項目	有鉛製程	無鉛製程
預熱與浸泡		
溫度最小值(Tsmin)	100 °C	150 °C
溫度最大值(Tsmax)	150 °C	200 °C
時間(Tsmin to Tsmax)(ts)	60-120 seconds	60-120 seconds
平均爬升率(Tsmax to Tp)	3 °C/second max.	3 °C/second max.
液化溫度 (TL)	183 °C	217 °C
液化時間 (tL)	60-150 seconds	60-150 seconds
峰值封裝主體溫度(Tp)*	230 °C ~235 °C *	255 °C ~260 °C *
分級溫度(Tc)	235 °C	260 °C
分級溫度(Tc)在 5 °C 之內 的 確切時間(tp)**	20** seconds	30** seconds
平均下降率 (Tp to Tsmax)	6 °C/second max.	6 °C/second max.
25 °C 至溫度尖峰的時間	6 minutes max.	8 minutes max.
<p>*溫度曲線尖峰值 (Tp) : 溫度公差的定義為供應者的最小值與使用者的最大值 **溫度曲線尖峰值 (tp) : 時間公差的定義為供應者的最小值與使用者的最大值</p>		



SENSOR SWITCH

Item No.	RBS3201 系列	Description	TILT SWITCH	Version	14
Page	13 of 15		Date	Oct. 05, 2015	

(圖 5)

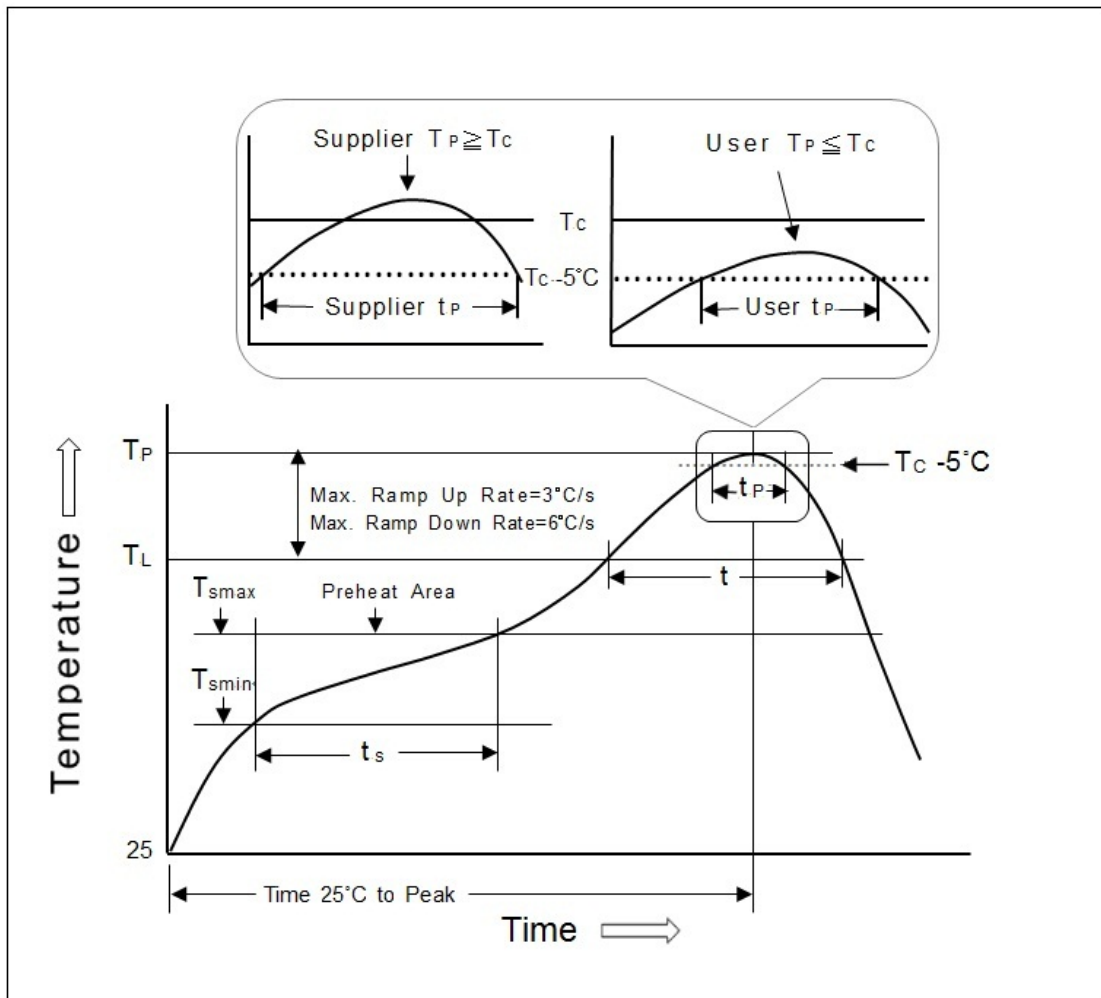

SENSOR SWITCH

Item No.	RBS3201 系列	Description	TILT SWITCH	Version	14
Page	14 of 15		Date	Oct. 05, 2015	

● 包裝

	料 號	包 裝	數 量	總 數	尺寸(mm)
1.	RBS320100	IC 管	62 pcs	62 pcs	525L*10W*17.5H
	RBS320102	內箱	120 支	7,440 pcs	539L*130W*130H
	RBS320103				
	RBS320110	外箱	4 內箱	29,760 pcs	551L*285W*288H

※ 包裝流程如下：產品圖片僅供參考！



SENSOR SWITCH

Item No.	RBS3201 系列	Description	TILT SWITCH	Version	14
Page	15 of 15		Date	Oct. 05, 2015	

● 備註

1. 使用建議：使用於具震動場合時，建議加上 on delay 的設計；若震動過大時，建議選用光電式產品。
2. 由於公司政策是不斷的改善產品品質，因此規格書可能在沒有知會的情況下變更或修改，您可以透過本公司的業務人員取得最新資訊。在一般情況下，本公司所有產品都是依照規格書的標準條件生產。

● 注意事項

1. 如果該產品要用於其它具有更高安全性及可靠性的耐久設備中(如生命維持裝置、宇宙航空裝置、防災及安全性裝置)時，請確認是否合用，或者問我方瞭解詳細情況。
2. 焊接流程完成後，請勿使用溶劑或類似物品清洗開關。
3. 使用水溶性助焊劑可能導致開關破損。
4. 當焊接溫度超過規格書規範時，開關可能會分離。
5. 不要將開關用於高濕或有沾濕可能性的環境中，因這樣的環境可能會引起端子間之漏電流。
6. 超過額定負荷使用時，有發生火災的可能性，故請勿超過負荷使用。
7. 於電路中不得靠近或與強磁元件焊點直接接通(例如:繼電器、變壓器..等)。
8. 為預防 IR、PT 受損，請做靜電防護處理，例如：製程中使用導電腕帶或防靜電手套、設施機台做接地處理等。

