



淮 洋 有 限 公 司 HUI YANG CO., LTD.

TEL : 886-2-8261-8986 FAX : 886-2-8261-1885

www.hy1688.com.tw 236新北市土城區中央路二段191號10樓之5

Rocker Switch R6 Series



SPECIFICATION

- Electrical Rating : 6A 250VAC/10A 125VAC(UL) 4(1)A 250VAC(VDE)
- Mechanical life: Over 30000 cycles
- Electrical life: Over 10000 cycles
- Contact resistance: <math><20\text{m}\Omega</math>
- Insulation resistance: >1000M Ω
- High voltage resistance: >1500V 1 min.
- Ambient temperature: Terminal side -20 to +85 $^{\circ}\text{C}$
Actuating side -20 to +55 $^{\circ}\text{C}$
- Storage temperature: -30 ~ +85 $^{\circ}\text{C}$ Max
- Atmospheric humidity: Max.85%
- Actuating force: 4N
- Flammability: UL94 V-2
- Temperature rise at the terminal: Max 30 $^{\circ}\text{C}$ (UL1054)
- Solder ability of terminal: Max 350 $^{\circ}\text{C}$, 3s

MATERIALS

- Housing: PA 66
- Rocker: PA66
- Contacts: Silver Alloy
- Terminal: Brass Silver Plated
- Movable Arm: Copper Silver Plated

HOW TO ORDER

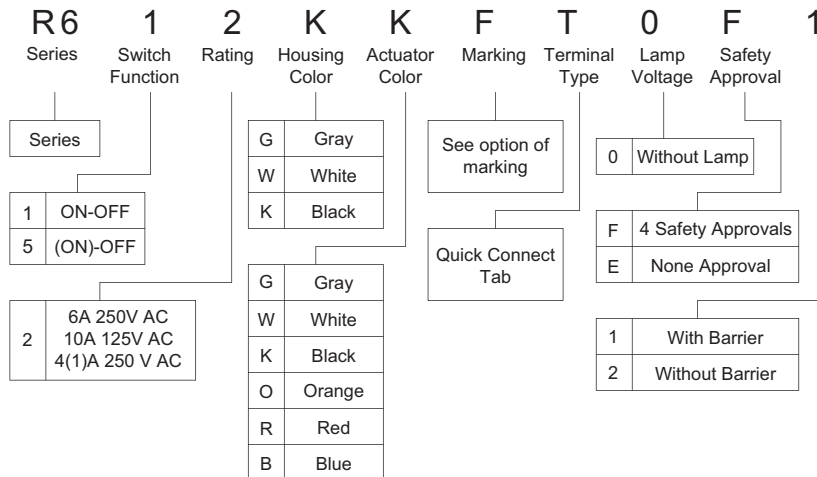

Option of switch function

Item NO	POLES & THROWS	Rocker position ():Momentary		
		Left	Center	Right
R61	SPST	ON	None	OFF
R65	SPST	(ON)	None	OFF



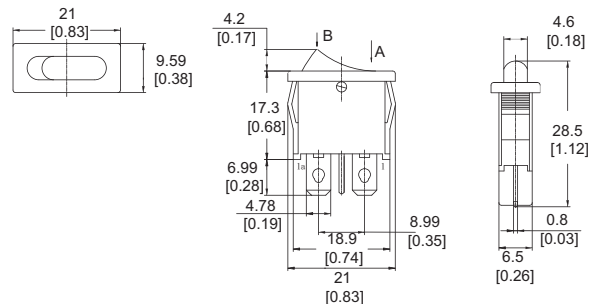



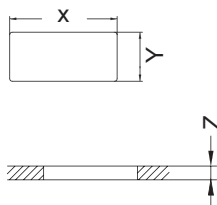











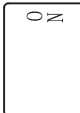







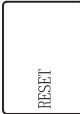
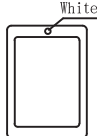
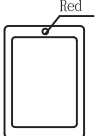
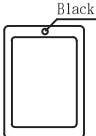
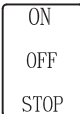

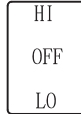

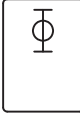







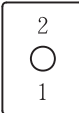

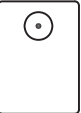

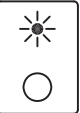



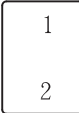

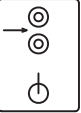
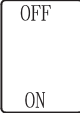
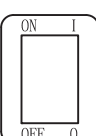
Dimension

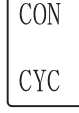

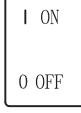
Panel cut out

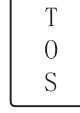
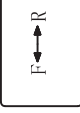

Z	Y	X
0.70~1.25	6.65~6.75	19.20~19.30
1.25~2.00	6.65~6.75	19.25~19.35
2.00~3.00	6.65~6.75	19.30~19.40

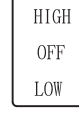
 A	 B	 C	 D	 E	 F	 G	 H	 I
 J	 K	 L	 M	 N	 O	 P	 Q	
 S	 T	 U	 V	 W	 X	 Y	 Z	 1A
 1B	 1C	 1D	 1E	 1F	 1G	 1H	 1I	 1J
 1K	 1L	 1M	 1N	 1O	 1P	 1Q	 1R	 1S
 1T	 1U	 1V	 1W		 1Y	 1Z	 2A	 2B
 2C	 2D	 2E	 2F	 2G	 2H	 2I	 2J	 2K