

# RoHS Compliance

| REVISIONS |               |          |       |
|-----------|---------------|----------|-------|
| LTR       | DESCRIPTION   | DATE     | APP   |
| △         | CAR 2.80±0.25 | 01/17/08 | CHANG |

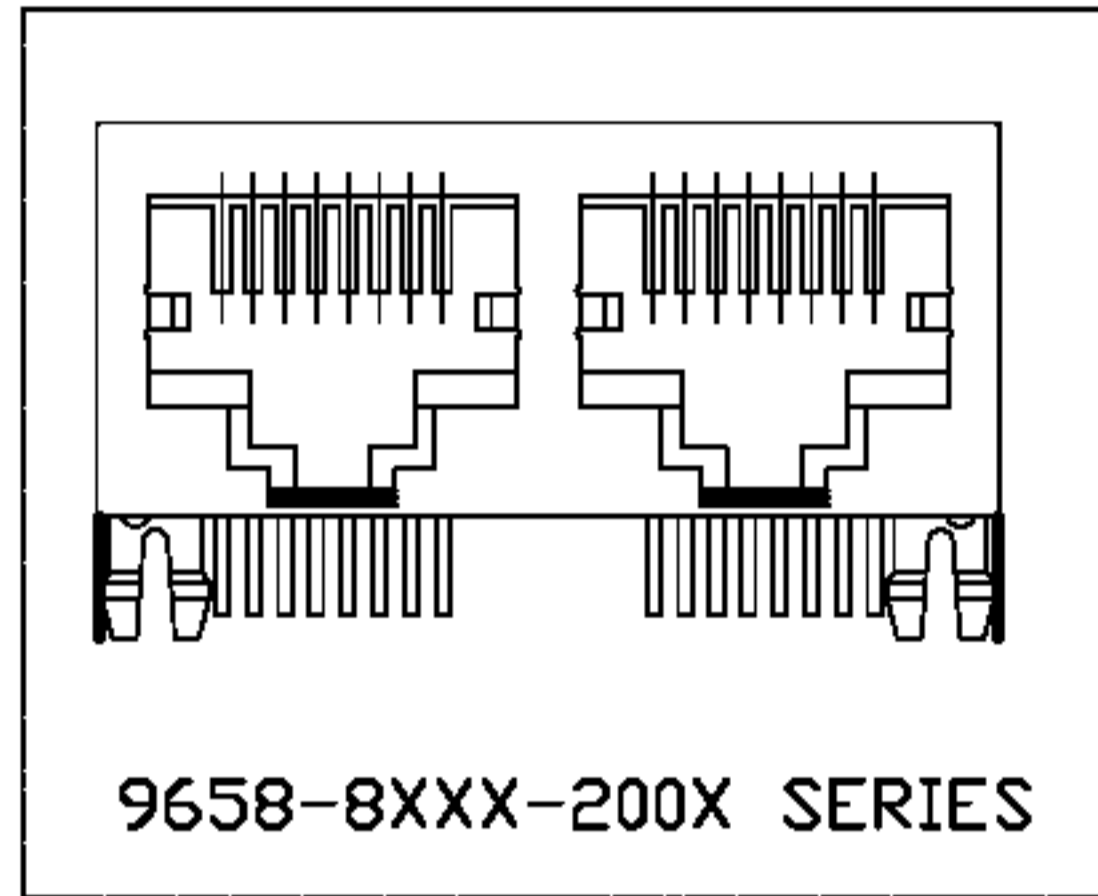

LEFT PANEL GROUND

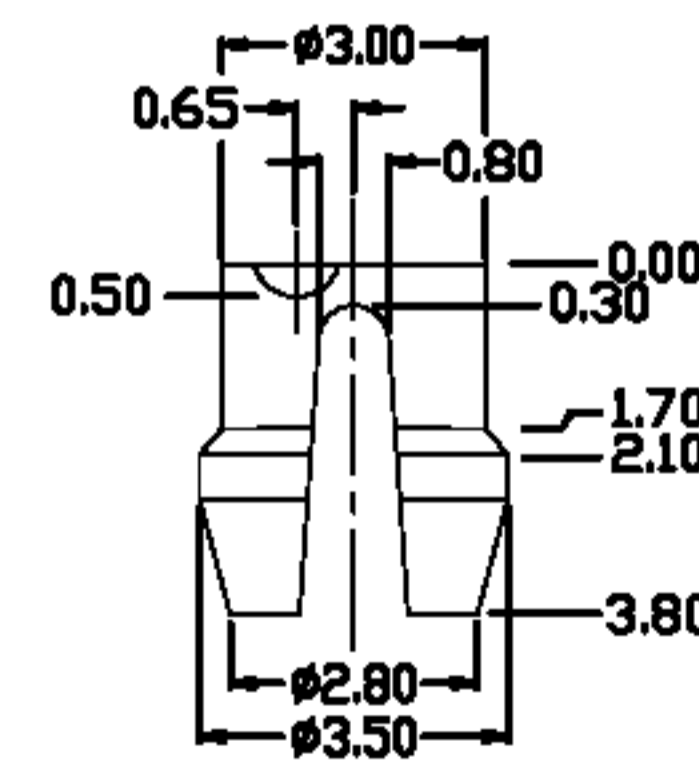
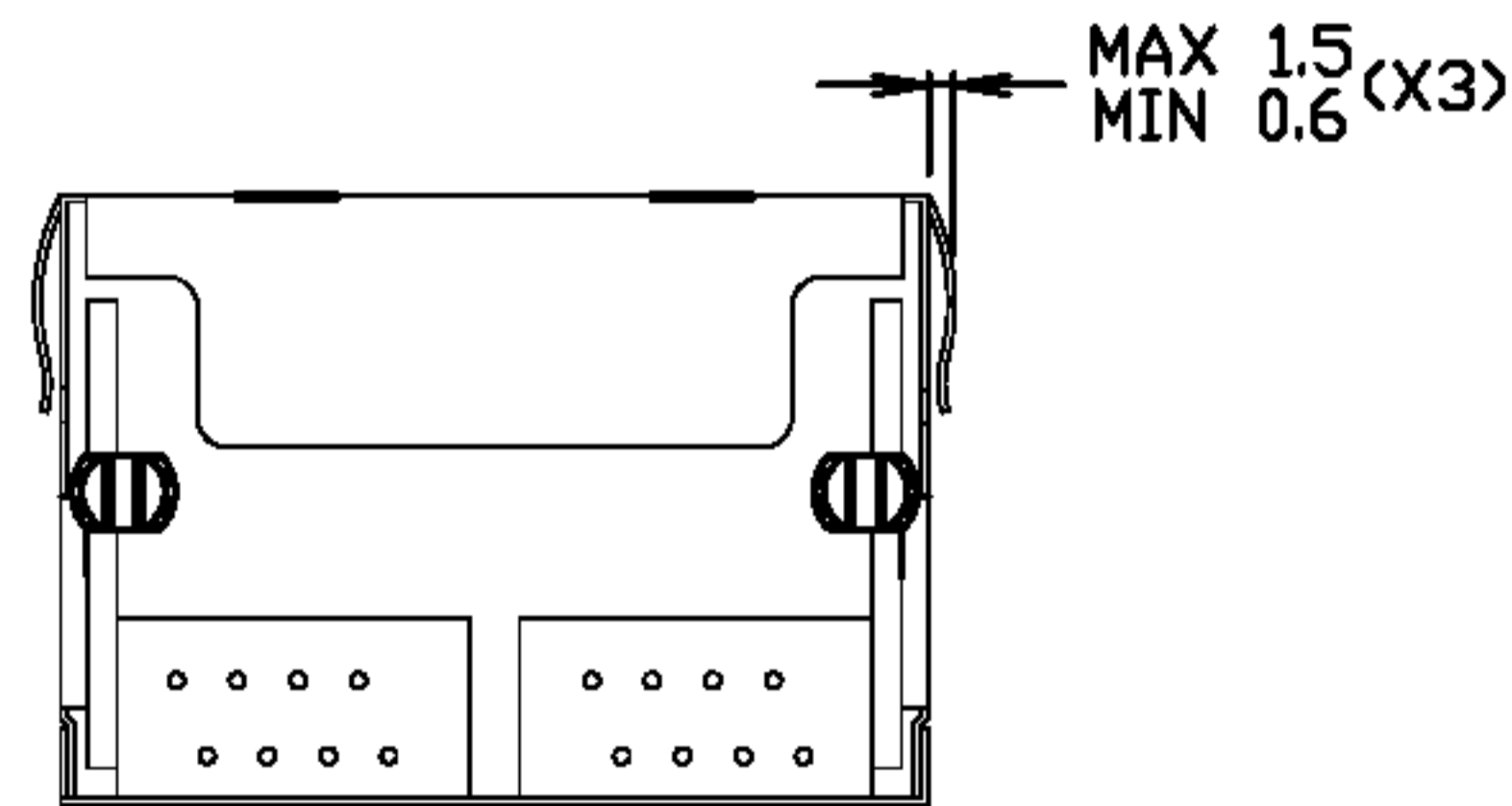
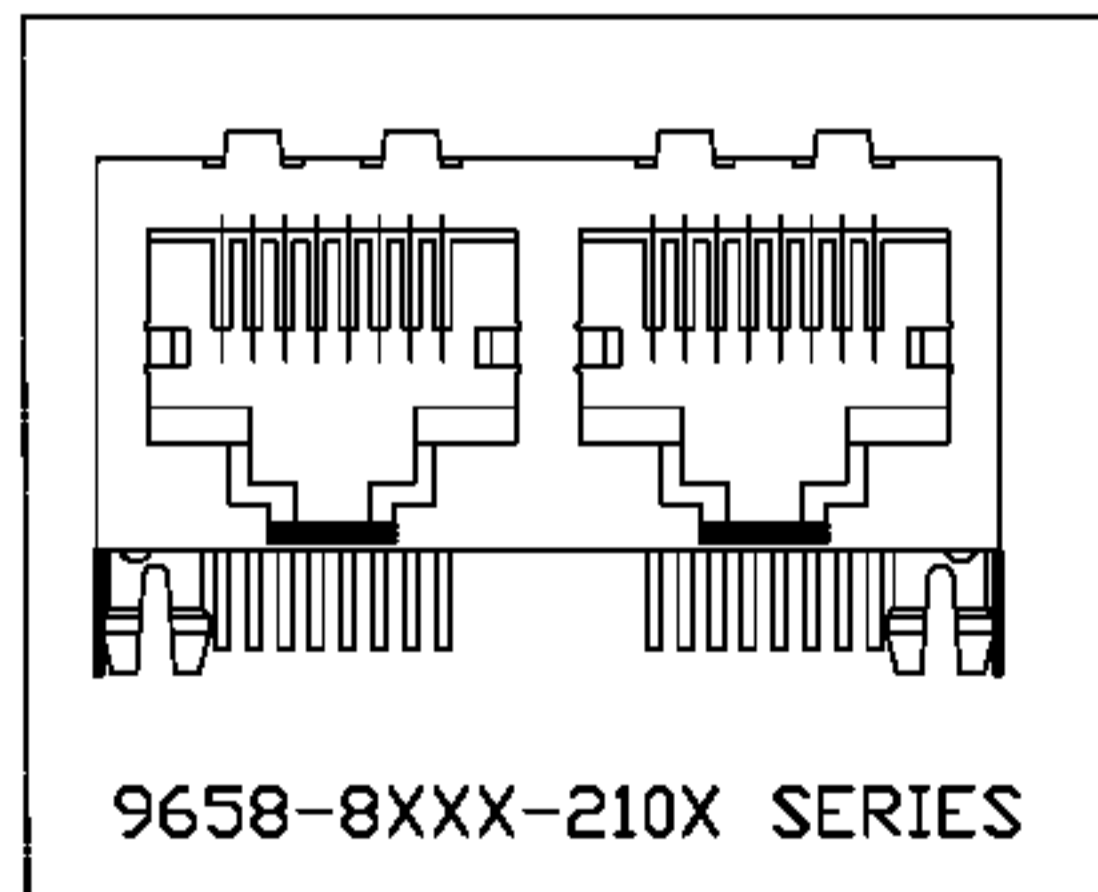
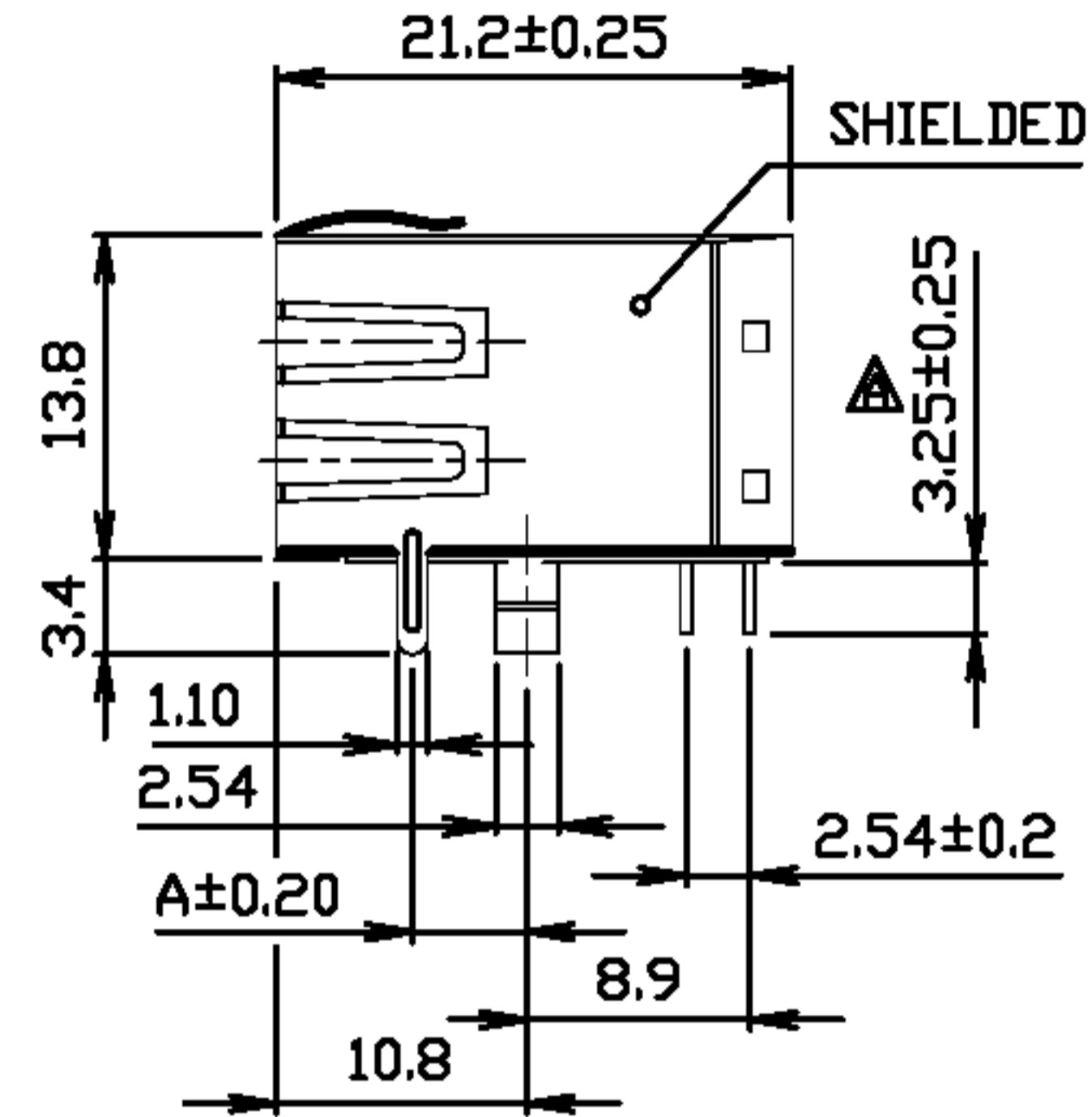
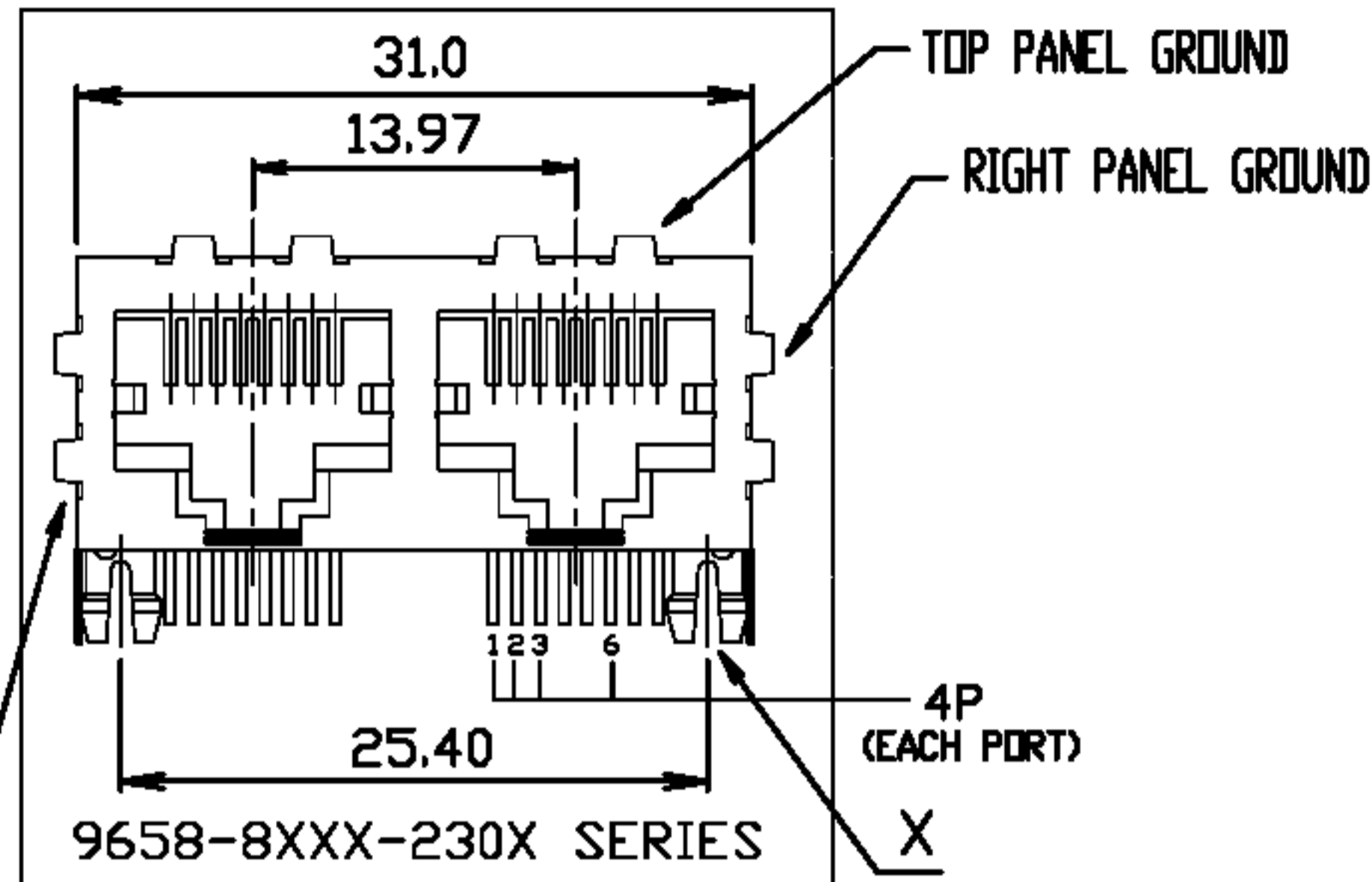

DETAIL X

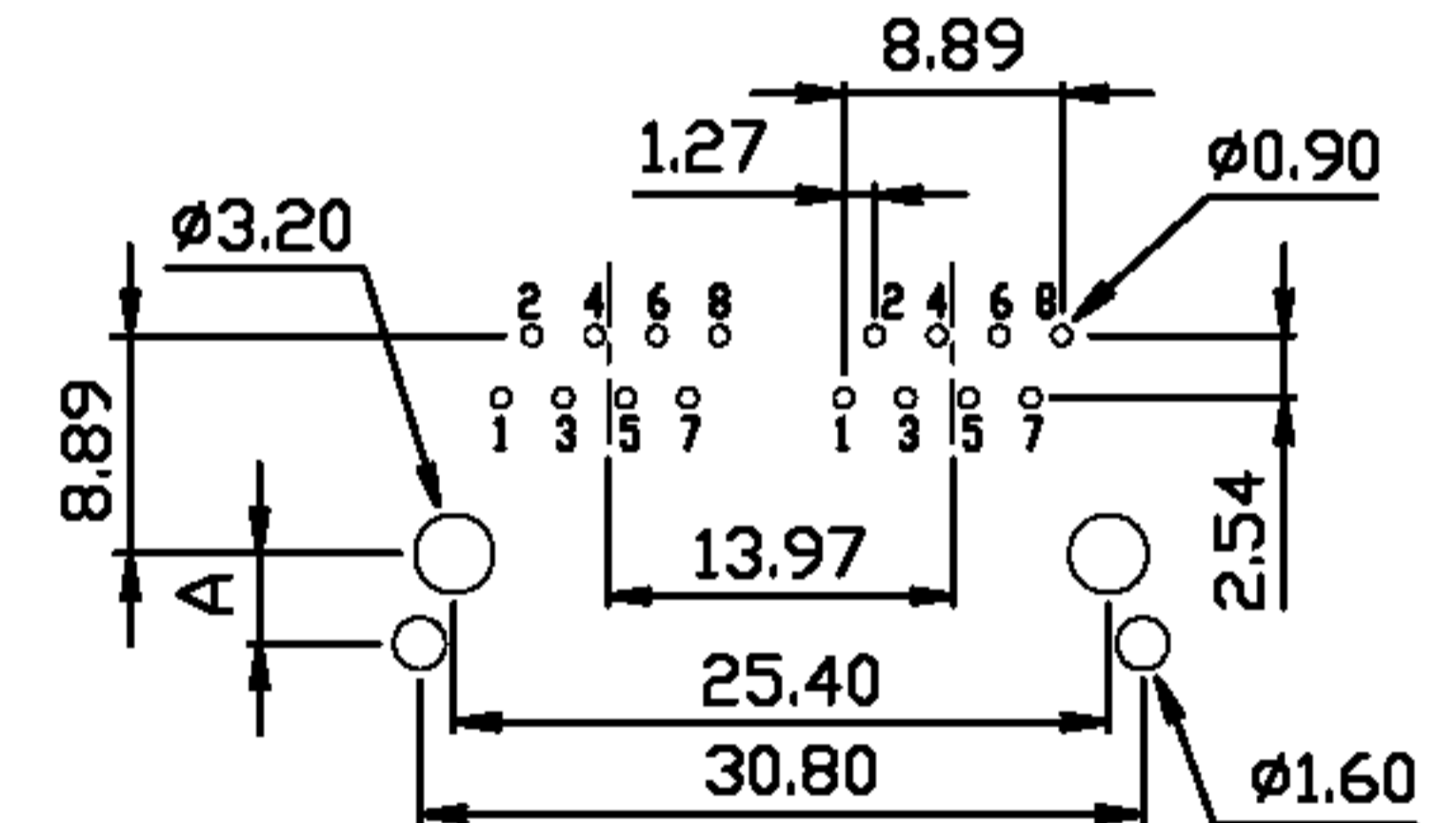

PCB LAYOUT Ref.

|                        |                                   |                                       |                                           |                    |                    |
|------------------------|-----------------------------------|---------------------------------------|-------------------------------------------|--------------------|--------------------|
| DO NOT SCALE DRAWING   | TOLERANCES UNLESS OTHERWISE NOTED | INCH                                  | MM                                        | DR.<br>CIAN.CI.LUO | DATE<br>JAN-17 '08 |
| THIRD ANGLE PROJECTION | LINEAR<br>MM<br>INCH              | 00 ± .01<br>000 ± .005<br>0000 ± .002 | 0.0 ± 0.25<br>0.00 ± 0.13<br>0.000 ± 0.05 | CK'D<br>M.CHANG    | JAN-17 '08         |
| MM<br>INCH             | ANGLE ± 0° 30'                    | RADII                                 | + 0.40<br>- 0.15                          | APP'D<br>W.J.YANG  | JAN-18 '08         |

淮洋有限公司 HUIYANG CO., LTD.  
TEL : 886-2-8261-8986 FAX : 886-2-8261-1885  
www.hy1688.com.tw 236新北市土城區中央路二段191號10樓之5

TITLE 2 PORTS 8POSITION SHIELDED  
FLAT PIN SIDE ENTRY PCB GANGED JACK

| SCALE | SIZE | DWG.NO. | REV. | SHEET |
|-------|------|---------|------|-------|
|       |      | 965803  | 3    | 1     |