

Technical Data Sheet- Light Receiving Unit

DATA LINK : DLR1142

Features

- High PD sensitivity for red light
- High speed up to 16 Mbps
- Low power consumption and current dissipation
- +3~+5V power source

Descriptions

The light receiving unit is a standard-package product with connector and opto-electric component packaged with PD and I/V amplifier IC. The function of unit changes the light signal into electric signal.

The unit is operated at +3~+5V and the input signal is TTL compatible. The DLR1142 has a maximum operating speed of 16 Mbps.

Applications

- Audio equipment
- Digital optical data link
- MD
- Sound card



Device Selection Guide

Chip		Operating Voltage (Vcc)	Dissipation Current(mA)	Fiber Coupling Light Output (dBm)		
IC Material	LED p(nm)			Typ.	Min.	Typ.
Si	700	2.7~5.5	6.5	-24	-	-14.5

Technical Data Sheet- Light Receiving Unit

DATA LINK : DLR1142

Package Dimensions

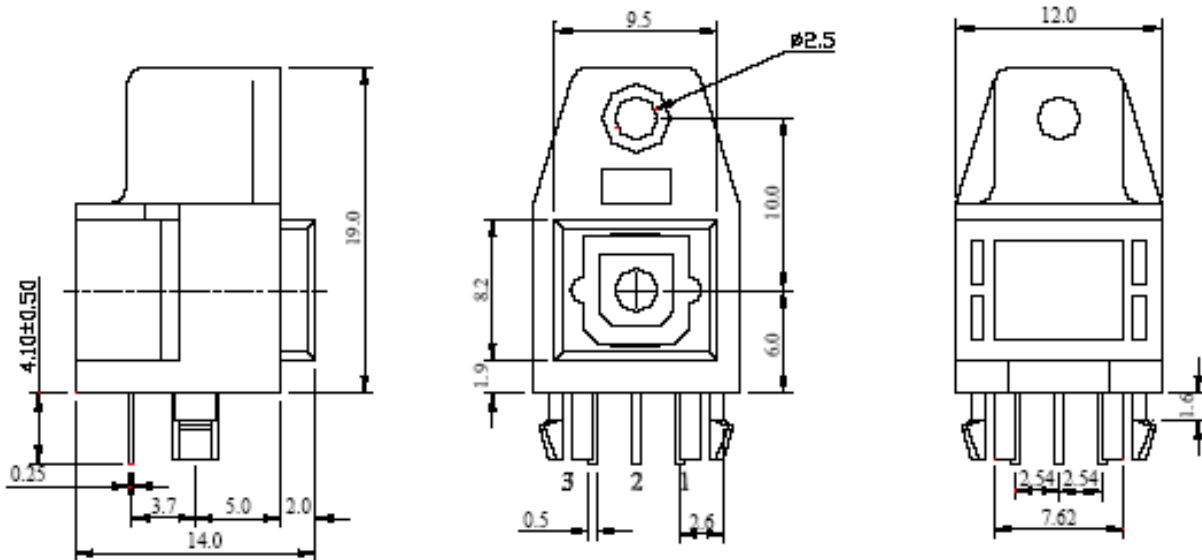

- Notes:** 1.All dimensions are in millimeters.
2.General Tolerance:±0.2mm

Pin Function

1. Vout
2. GND
3. Vcc

Absolute Maximum Ratings(Ta = 25)

Parameter	Symbol	Rating	Unit
Supply Voltage	Vcc	5.5	V
Storage Temperature	Tstg	-30 to 80	
Operating Temperature	Topr	-20 to 70	
Soldering Temperature	Tsol	260*	

* Soldering time ≤ 5s / 2times.

Technical Data Sheet- Light Receiving Unit

DATA LINK : DLR1142

Electro-Optical Characteristics

Parameter	Symbol	Conditions	MIN.	TYP.	MAX.	Unit
Operating Voltage	V _{cc}	-	2.7	-	5.5	V
Peak Detective Wavelength	λ_p	-	-	700	-	nm
Transfer Speed		NRZ signal	0.1	-	16	Mbps
Receiving Distance		Using APF	0.2	-	20	m
Pulse Width Distortion	Δtw	16Mbps NRZ Signal	-20	-	20	ns
Input Light power	P _i	*1	-24	-	-14.5	dBm
Dissipation Current	I _{cc}	*2	-	6	10	mA
High Level Output Voltage	V _{OH}		2.4	-	-	v
Low Level Output Voltage	V _{OL}		-	-	0.4	v
Rise Time	t _r	*3	-	-	25	ns
Fall Time	t _f	*3	-	-	25	ns
Low → High propagation delay time	t _{PLH}	*3	-	-	100	ns
High → Low propagation delay time	t _{PHL}	*3	-	-	100	ns
Jitter time	Δt_j	*3	-	1.5	15	ns

The DLR1142 light receiving unit satisfies EIAJ CP-1201 digital audio interface standard.

Technical Data Sheet- Light Receiving Unit

DATA LINK : DLR1142

Reliability Test Items

No.	Item	Test Condition	Test Hour/Cycle	Samples	Number (n) Failure (c)
1	Soldering Heat	260 ±5	5 sec./2times	22	n=22, c=0
2	High temp. & Hum. storage	Ta=40 , 90%RH	500	22	n=22, c=0
3	High temp. storage	Ta=80	500	22	n=22, c=0
4	Low Temp. storage	Ta=-30	500	22	n=22, c=0
5	Temp. cycling	-30 ~ 80 (30min) (5min) (30min)	20	22	n=22, c=0
6	High Temp. Operation life	Ta=60 , Vcc=5V ON	500	22	n=22, c=0
7	Repeated operation	500 times	Coupling force < 2 kg 0.4kg<Detaching force <2kg	22	n=22, c=0
8	Terminal Strength(tension)	Weight: 500 g 30 sec./each terminal		22	n=22, c=0
9	Terminal Strength(bending)	Weight: 500 g 2 times/each terminal		22	n=22, c=0
10	Mechanical Shock	Acceleration: 1000m/s ² Pulse width: 6 ms 3 times/ X,Y,Z direction		22	n=22, c=0
11	Vibration	Frequency range: 10~55 Hz /sweep 1 min Overallamplitude:1.5 mm 2H./X,Y,Z direction		22	n=22, c=0

I_{cc} (dissipation current): CURRENT ATTENUATE DIFFERENCE < 20%

T_{PLH} (propagation L → H delay time): DELAY TIME DIFFERENCE < 20%

T_{PHL} (propagation H → L delay time): DELAY TIME DIFFERENCE < 20%

T_r (rise time): TIME DIFFERENCE < 20%

T_f (fall time): TIME DIFFERENCE < 20%

Technical Data Sheet- Light Receiving Unit

DATA LINK : DLR1142

Measuring Method

- *1 Maximum receiver input optical power/Minimum receiver input optical power

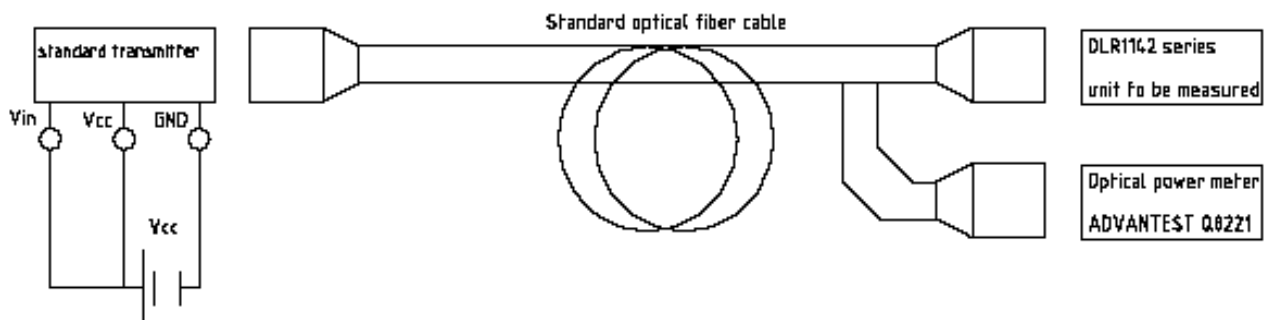

- *2 Current dissipation measuring method

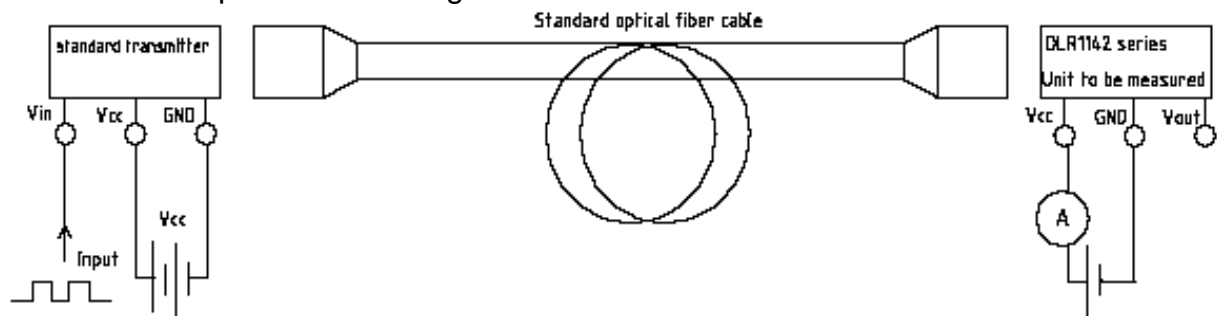

- *3 Pulse response and jitter measuring method

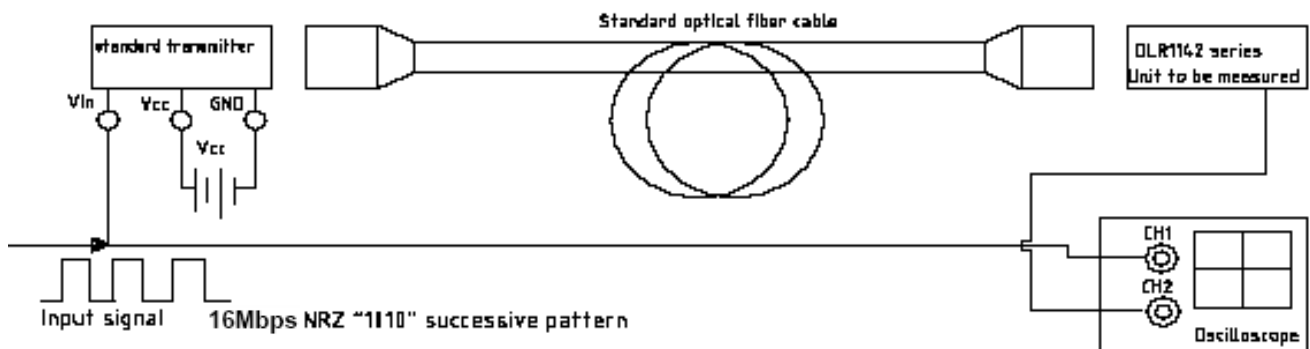

Technical Data Sheet- Light Receiving Unit

DATA LINK : DLR1142

PCB Layout For Electrical Circuit

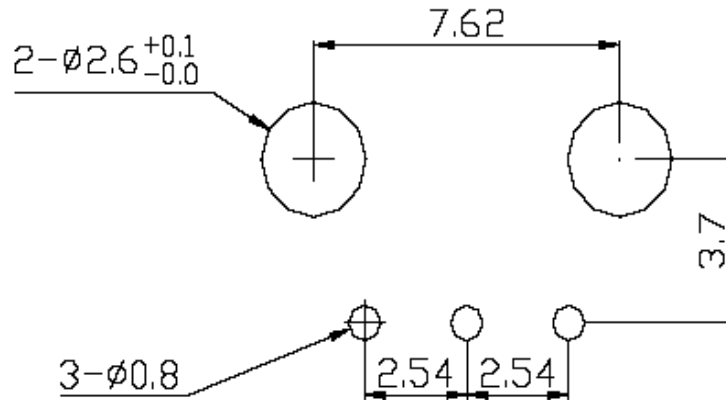

Notes:

1. Unit: mm
2. Unspecified tolerance: $\pm 0.3\text{mm}$
3. Substrate Thickness: 1.6mm

Precautions for Using Method

1. Connect a by-pass capacitor (0.1 μF) close to the DLR1142 within 7 mm of the unit lead frame.
2. Connect a by-pass capacitor (30pF) between GND and Vout avoid loading effect.
3. Take proper electrostatic-discharge (ESD) precautions while handling these devices. These devices are sensitive to ESD.

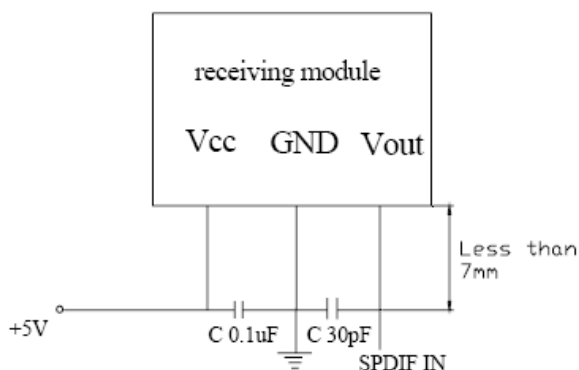

Technical Data Sheet- Light Receiving Unit

DATA LINK : DLR1142

Package

Item	Quantity	Total	Size (long*width*high)
Tray	1	100 pcs	13.5*27*3 cm
Inner box	20 tray/box	2000 pcs	29*29*22 cm
Outer box	2 inner box/outer box	4000 pcs	60*31*25.8 cm

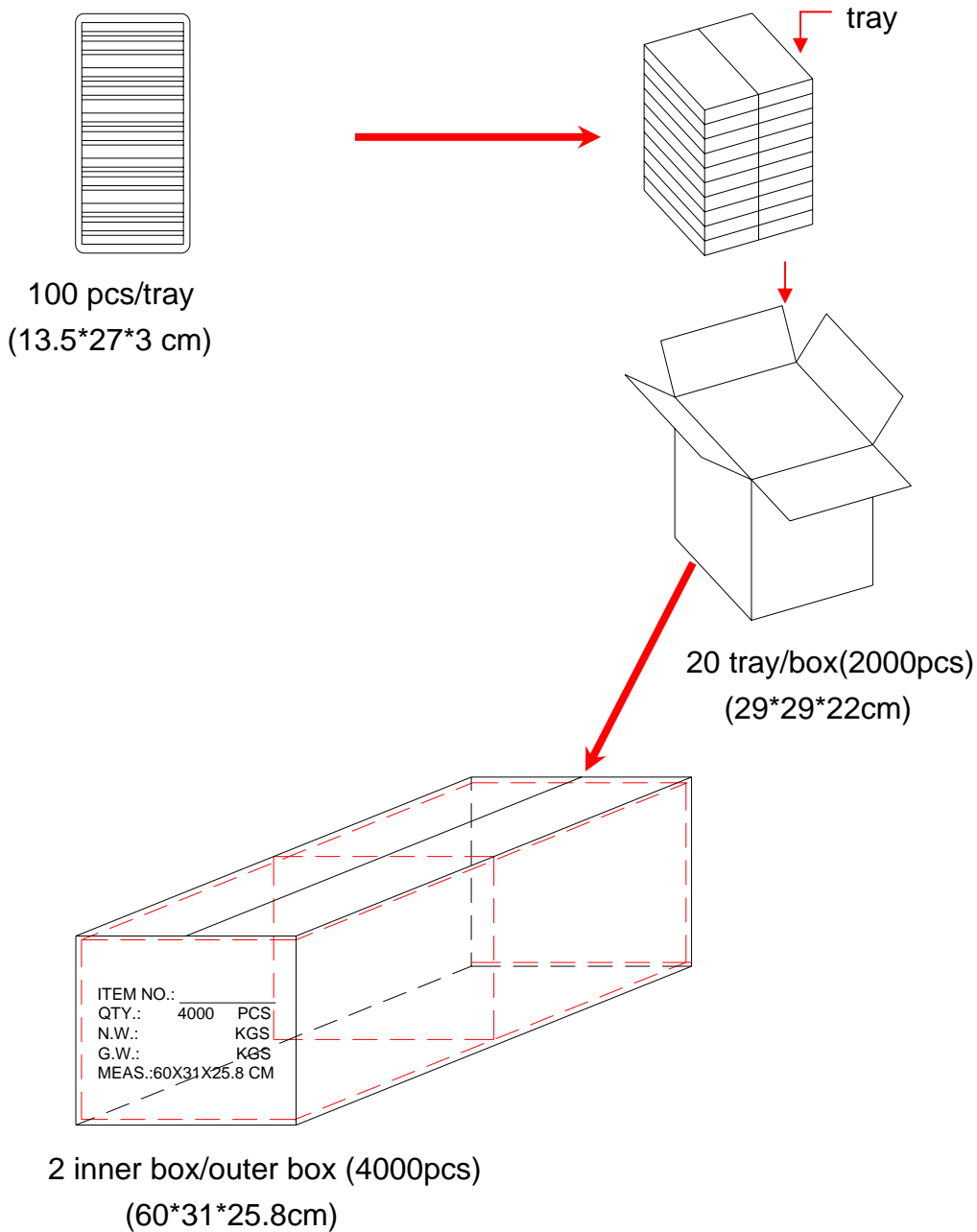

Technical Data Sheet- Light Receiving Unit
DATA LINK : DLR1142

REV	DESCRIPTION	RELEASE DATE