

F

E

D

C

B

A

RoHS
Compliant

| ZONE | SYMBOL | REVISION | APPROVAL | DATE |
|------|--------|---------------|-----------|-----------|
| | | ADD MATE PLUG | J.X.KUANG | 25-9-2006 |
| | | | | |
| | | | | |

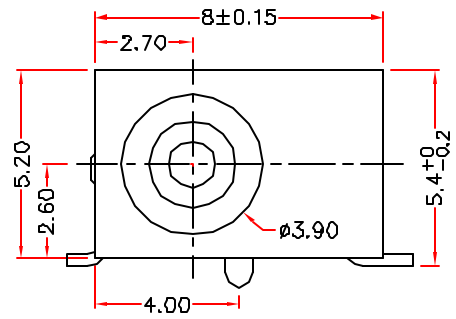
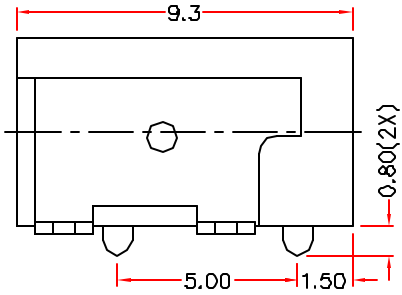
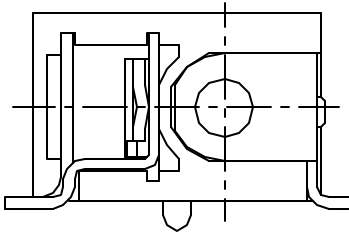
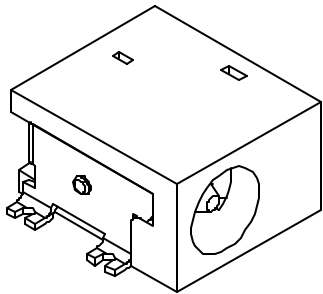

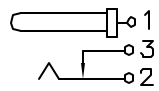
| | |
|------------|---|
| MODEL NO. | HDC-801H |
| SCHEMATIC |  |
| CENTER PIN | ø1mm |
| | ø1.3mm |

- * MATERIAL:
- CENTRE PIN : COPPER
 - TERMINAL 1 : BRASS
 - TERMINAL 2 : COPPER ALLOY
 - TERMINAL 3 : BRASS
 - HOUSING : PA6T

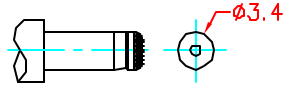
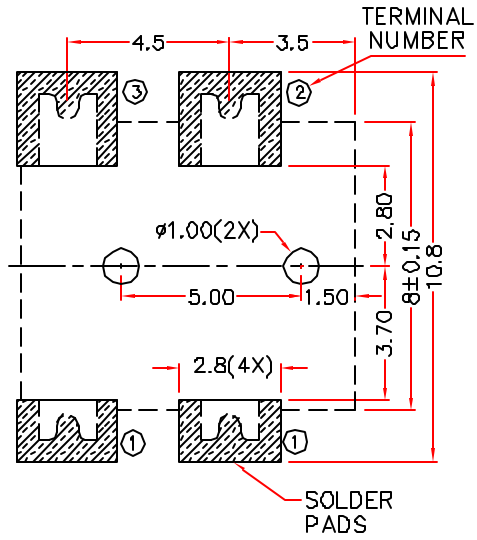
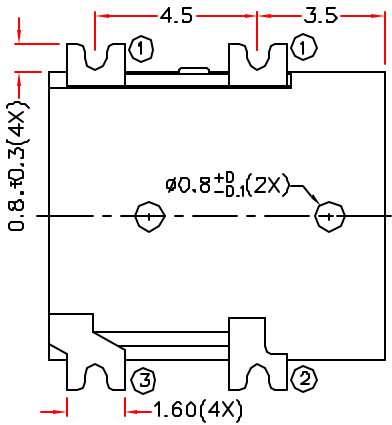

DC MATE PLUG

HUAI YANG CO.,LTD. 淮洋有限公司 TEL:886-2-8261-0858

| | | | | | |
|----------|-----------|------|-----------|----------|------------------|
| DESIGN | L.L.ZHANG | DATE | 29-7-2005 | SCALE | 5:1 |
| DRAWING | L.L.ZHANG | DATE | 25-9-2006 | MATERIAL | * |
| CHECK | | DATE | | DWG. NO. | TZ\DC018H-PA6T/E |
| APPROVAL | | DATE | | SHEET | |

| | | | | |
|-----------|----------------------------------|----------------------|------------------------|---|
| PART NAME | HIGH CURRENT SMD DC POWER SOCKET | TOLERANCE UNLESS | 0.0±0.2 | UNIT:  |
| PART NO. | HDC-801H | OTHERWISE SPECIFIED: | 0.00±0.1 0.000±0.05 | |

F

E

D

C

B

A

DCF-04/A