

F

E

D

C

B

A

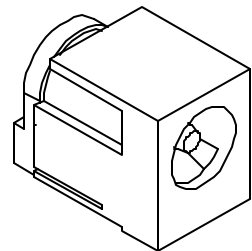

RoHS
Compliant

ZONE	SYMBOL	REVISION	APPROVAL	DATE
		ADD MATE PLUG	J.X.KUANG	30-9-2006

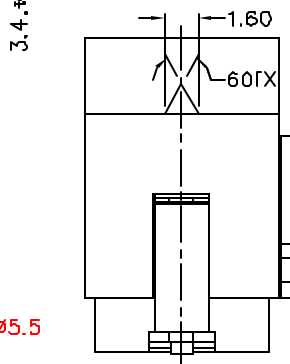
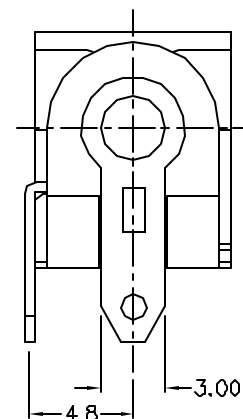
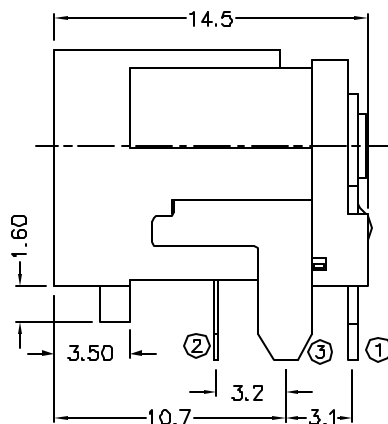
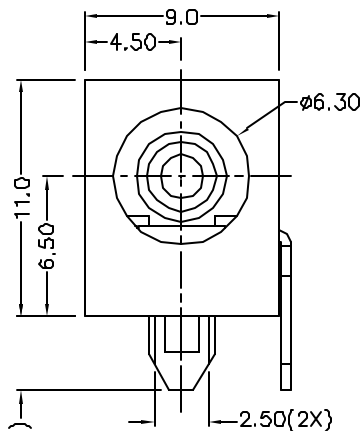

*** MATERIAL**

- CENTRE PIN : COPPER
- TERMINAL 1 : BRASS
- TERMINAL 2 : COPPER ALLOY
- TERMINAL 3 : BRASS
- HOUSING : PBT
- COVER : PBT

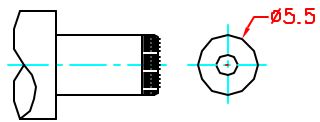
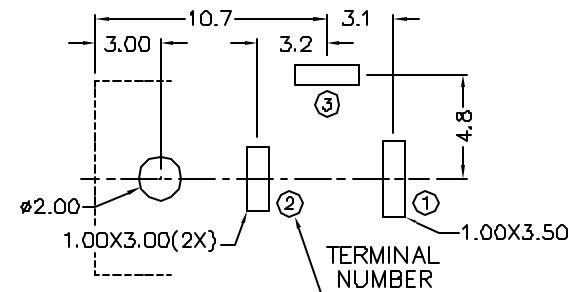

DC MATE PLUG

MODEL NO.	HDC-106H
SCHEMATIC	
CENTER PIN	ø2mm
	ø2.5mm

PCB LAYOUT
(BOTTOM VIEW)

HUAI YANG CO.,LTD. 淮洋有限公司 TEL:886-2-8261-0858

DESIGN	L.L.ZHANG	DATE	22-04-2005	SCALE	3:1
DRAWING	L.L.ZHANG	DATE	30-9-2006	MATERIAL	*
CHECK		DATE		DWG. NO.	TZ\DC061H-PBT/B
APPROVAL		DATE		SHEET	

PART NAME	HIGH CURRENT DC POWER SOCKET	TOLERANCE UNLESS	0.0±0.2	UNIT:
PART NO.	HDC-106H	OTHERWISE SPECIFIED:	0.00±0.1 0.000±0.05	

F

E

D

C

B

A DCF-04/A